

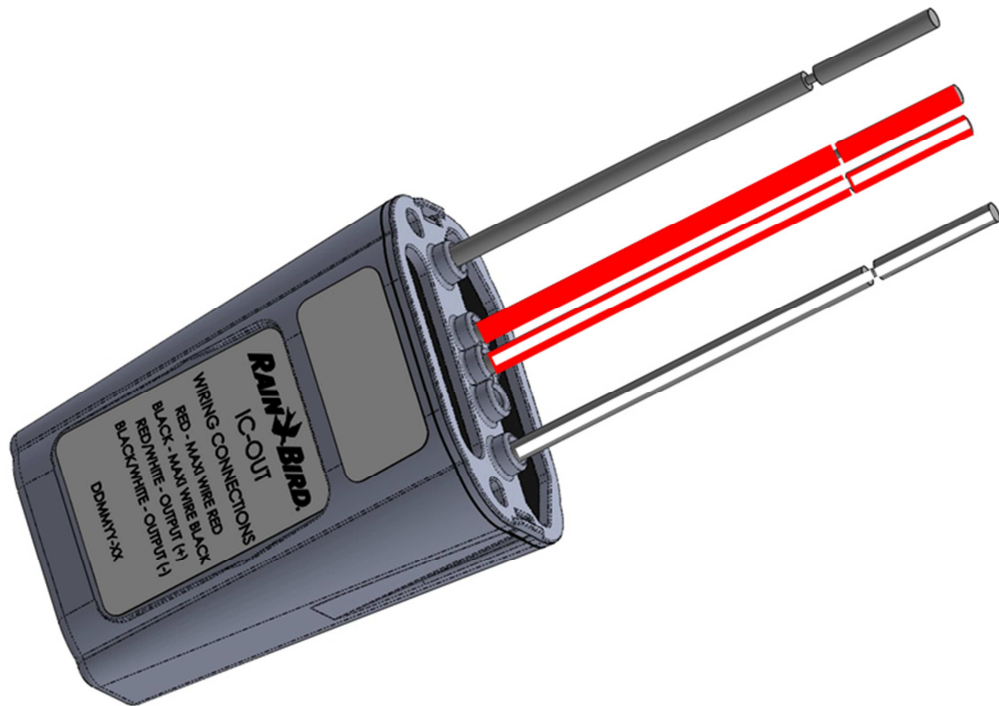

# Rain Bird® IC-OUT Integrated Control Output Device Installation Guide





*IMPORTANT NOTES: INSTALLING THE IC-OUT – Integrated Control Output Device* · 3

*Compliance Information* ..... 4

*Installation Checklist*..... 5

*Latching Relay Basics*..... 6

*Verify Compatible Rain Bird Central Control Software is Installed* ..... 10

*Verify Contents of the Packing Box*..... 11

*Choose Location to Install the IC-OUT*..... 12

*Gather Installation Tools / Other Materials Required* ..... 13

*Installation Step #1 - Connect IC-OUT Control Outputs*..... 14

*1.A - Output Connection steps for IC-OUT used in DC Latching Irrigation Control Valve Applications:*..... 15

*1.B - Output Connection Steps for Latching Relay Applications:*..... 16

*Installation Step #2 - Connect IC System™ Field Wiring* ..... 18

*Installation Step #3 - Complete Field Installation* ..... 19

*Installation Step #4 - Configure Rain Bird Central Control Software* ..... 21

*4.A – Setting Up General-Purpose Electrical Control Outputs* ..... 23

*“Best Practice” programming method for Activations Exceeding 8.5 hours* ..... 25

*4.B – Setting Up Booster Pump Control Outputs* ..... 27

*IC-OUT Specifications*..... 32

---

## **IMPORTANT NOTES: INSTALLING THE IC-OUT – Integrated Control Output Device**

This section explains how to install and configure the IC-OUT device.



**NOTE:** The IC-OUT device must be installed in compliance with all electrical codes.



**NOTE:** The installation of the IC-OUT device should be performed with the IC System™ wire path unpowered.



**NOTE:** The IC-OUT device requires time to initialize. Always wait two minutes after the wire path has been powered before attempting any operation with the IC-OUT device.



**WARNING:** Field wire paths must be kept separate from other wire paths. Do not connect the field wires together from different output (group) wire paths on the ICI - Integrated Control Interface



**WARNING:** This appliance is not intended for use by persons (including children) with reduced physical, sensory or mental capabilities, or lack of experience and knowledge, unless they have been given supervision or instruction concerning use of the appliance by a person responsible for their safety.



**WARNING:** Children should be supervised to ensure that they do not play with the appliance.



---

## Compliance Information



This device complies with Part 15 of the FCC rules subject to the following two conditions:



- (1) This device may not cause harmful interference, and
- (2) This device must accept any interference received, including interference that may cause undesired operation.

This Class B digital apparatus meets all requirements of the Canadian Interference Causing Equipment Regulations.

EN61000-6-1 (1997) Class B:

EN61000-3-2  
EN61000-3-3

EN61000-6-3 (1996):

EN61000-4-2  
EN61000-4-3  
EN61000-4-4  
EN61000-4-5  
EN61000-4-6  
EN61000-4-8  
EN61000-4-11



EN 60335-1: 2010 Safety of household and similar electrical appliances



---

## ***Installation Checklist***

The following steps are recommended in order to properly install the IC-OUT device. For your convenience, a check-off box has been provided for each step.

- Review Latching Relay Basics (if applicable)
- Verify Compatible Rain Bird Central Control Software is Installed
- Verify the contents of the packing box.
- Choose a location to install the IC-OUT.
- Gather Installation Tools / Other Materials Required
  - Latching Relay Applications (Pumps, Fans, Fountains, etc...)
    - DIN Mounting Rail
    - Purchase DC Latching Relay Schneider Electric (**785XBXC-24D**)
    - Purchase relay mounting socket Schneider Electric (**70-463-1**)
- Connect control outputs
  - Latching Relay Applications (Pumps, Fans, Fountains, etc...)
  - DC Latching Irrigation Control Valve Applications
- Connect IC System™ field wiring
- Complete the installation
- Configure Rain Bird central control software



---

## ***Latching Relay Basics***

### **A. Using IC-OUT with a Latching Relay: (Pumps, Fans, Fountains, etc...)**

A latching relay switches an external power input between two external power output terminals based on the “state” of the relay.

External power output terminal options are:

- 1) Normally Open (N/O) terminal meaning that in the OFF state of the relay no electrical connection exists between the input and output external power terminals. No electrical connection results in no power being applied to the connected device controlled by the latching relay.
  - a. When the relay is activated (ON position) the relay state changes; the Normally Open connection is closed inside the relay and power is allowed to flow between the input and output terminals, thus powering a connected device.
  - b. Think of this operation as being like a light switch connection. In the OFF position the lightbulb is off but when activated (ON position) the lightbulb turns on.
  
- 2) Normally Closed (N/C) terminal meaning that in the OFF state of the relay electrical connectivity exists between the external power input and output terminals. As a result the connected device controlled by the relay is normally energized.
  - a. When the relay is activated (ON position) the state changes and the Normally Closed connection is interrupted; stopping power from flowing between the input and output terminals and de-energizing any device which is connected.

## B. Electrical Diagram & Terminal Socket Diagrams:

The diagrams below show the electrical connection and terminal descriptions of the recommended DC latching relay and socket.

**Relay Electrical Diagram**

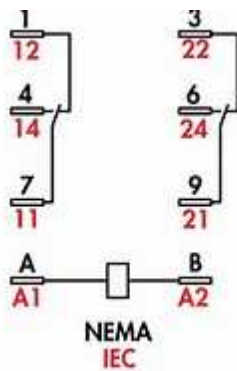

**Socket Terminal Identification**

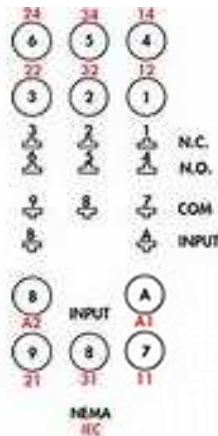

**Terminal Block Layout**

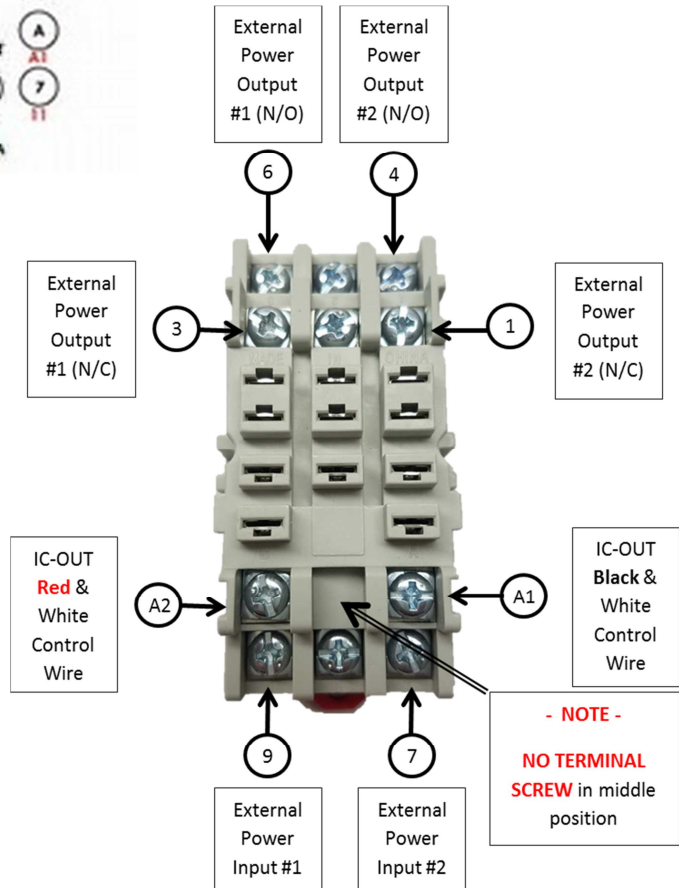

Use caution when making any connections to the terminal block as risk of electric shock may be present.



Based on the previous diagrams and IC-OUT operation:

- 1) When IC-OUT is in the OFF state:
  - a. The circuit between Terminal 9 and Terminal 3 is CLOSED
  - b. The circuit between Terminal 9 and Terminal 6 is OPEN
  - c. The circuit between Terminal 7 and Terminal 1 is CLOSED
  - d. The circuit between Terminal 7 and Terminal 4 is OPEN
  
- 2) When IC-OUT is in the ON state:
  - a. The circuit between Terminal 9 and Terminal 3 is OPEN
  - b. The circuit between Terminal 9 and Terminal 6 is CLOSED
  - c. The circuit between Terminal 7 and Terminal 1 is OPEN
  - d. The circuit between Terminal 7 and Terminal 4 is CLOSED
  
- 3) Note – There is never an electrical connection between
  - a. Terminals 7 - 3 & 6
  - b. Terminals 9 - 1 & 4



**NOTE:** During installation of the IC-OUT device in a latching relay application, and prior to powering on the IC System™ wire path, External power input may be electrically connected to either External power N/C or External power N/O outputs. If an external source voltage is applied to External power terminals, live power will be present at **either** External power N/C output or external power N/O output. After the IC System™ wire path has been powered for two (2) minutes, the IC-OUT will be placed in the OFF state, with External power input electrically connected to External power N/C output. Take care against touching any relay terminals or connected wires when any inputs or outputs are connected to live power. ***Isolate the relay before installation or service.***



**CAUTION:** All wiring runs and electrical equipment wiring connections must be made according to manufacturer directions and local building codes. Rain Bird recommends employing a licensed electrician to make all electrical connections in excess of 30 volts.



### C. Reference Pump Start Connection Diagram for IC-OUT:

Figure 1 below shows a typical IC-OUT application and connection diagram when coupled with the recommended DC latching relay for booster pump control.

- 1) The IC-OUT control outputs are connected to the recommended latching relay socket [terminals A1 & A2].
- 2) The external power input [terminal 9] on the relay socket is connected to one side of a suitable external power source for the pump starter coil (or a suitable voltage for a pump start relay). This is typically a low-voltage source, rather than wall power, for safety.
- 3) The external power N/O output [terminal 6] on the relay socket is connected to the other side of a suitable external power source for the pump starter coil.

When the IC-OUT is OFF, the relay is latched so that the external power N/O output terminal is not energized, keeping the starter coil/pump start relay OFF. When the IC-OUT is in the ON state from the central control computer; the relay is latched, external power input [terminal 9] is electrically connected to external power N/O output [terminal 6] and the starter coil/pump start relay will trigger pump activation.

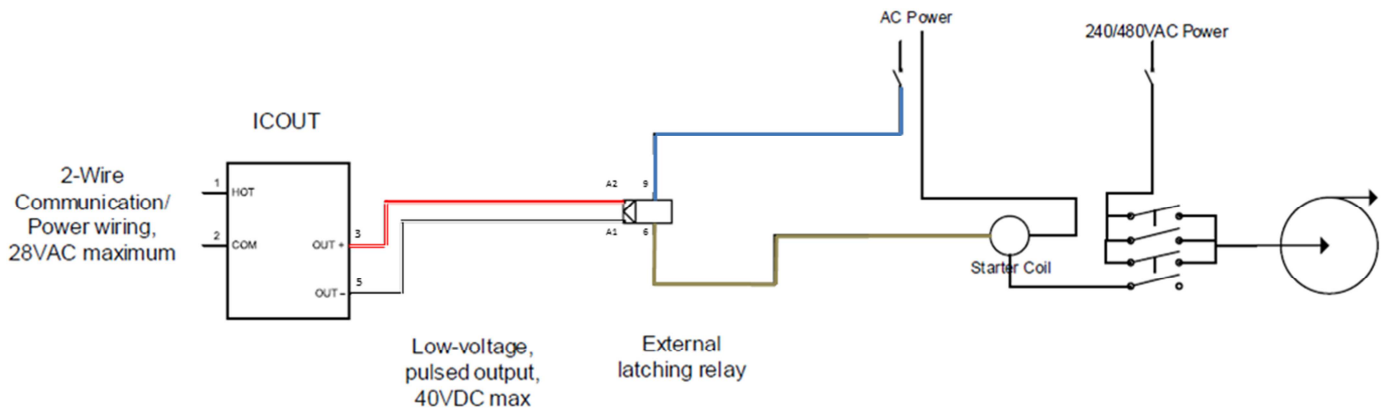

**Figure 1. IC-OUT Controlling a Latching Relay in a Pump Starter Coil Application**



## **Verify Compatible Rain Bird Central Control Software is Installed**

1. Verify Central Control software (Cirrus, Nimbus II, Stratus II or Stratus LT) is version 8.1.0 or higher. Attempting to use older software will result in unexpected operation.
2. Open the Central Control software and click on the “Rain Bird” icon in the front office.



3. If the software version is less than **8.1.0**, (as viewed below) contact your Rain Bird distributor for options to acquire new software. Rain Bird distributors and / or Rain Bird GSP can assist with software updates.



---

**Verify Contents of the Packing Box**

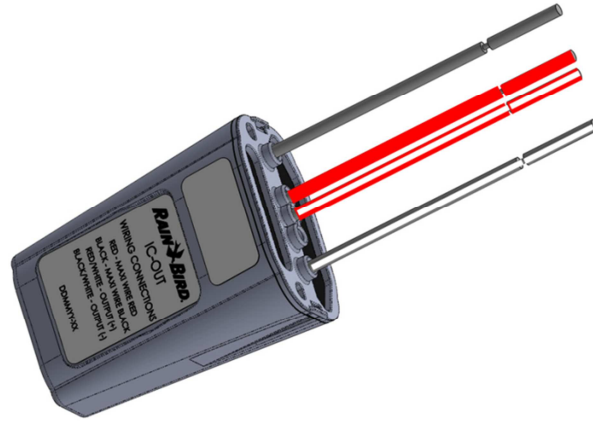

**IC-OUT Device**



---

## ***Choose Location to Install the IC-OUT***

1. Choose a location minimizing wiring length between IC-OUT and control output connections.
2. Choose a location with easy access to the IC System™ wire path.
3. Wherever possible, installation into a weatherproof enclosure is preferred but not required for proper operation of the IC-OUT device.
4. When installed below grade the device shall be housed in an accessible valve box with proper drainage.
5. Take caution to observe local electrical codes when installing the IC-OUT with a DC latching relay device.



**NOTE:** This and all other appliances must be installed in compliance with all electrical codes.

---

## Gather Installation Tools / Other Materials Required



Rain Bird Central Control **version 8.1.0** or higher

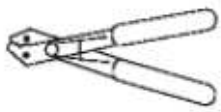

Wire strippers

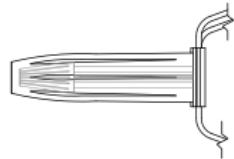

Rain Bird DBRY splice kits (2 - 4 splices)



DC Latching Relay

From Rain Bird: 001344 - GSP-ICRELAY KIT

From - TE Connectivity (Potter & Brumfield): KUL-11D15S-24

From - Schneider Electric (Magnecraft): 785XBXC-24D



DIN Rail Mounted Latching Relay Socket

From Schneider Electric (Magnecraft): 70-361-1



DIN Mounting Rail

---

## ***Installation Step #1 - Connect IC-OUT Control Outputs***

The IC-OUT device provides control output pulses in response to IC System™ commands received from the Rain Bird central control PC. The IC-OUT control output pulses are suitable for switching a latching relay or latching solenoid, which in turn can be connected to a variety of devices to enable operation of desired equipment via Rain Bird central control.



DC Latching Relay Assembly



DC Latching Solenoid

## 1.A - Output Connection steps for IC-OUT used in DC Latching Irrigation Control Valve Applications:

Figure 2 shows a typical IC-OUT application for irrigation valve control. The IC-OUT control outputs are connected to a latching solenoid on the irrigation valve.

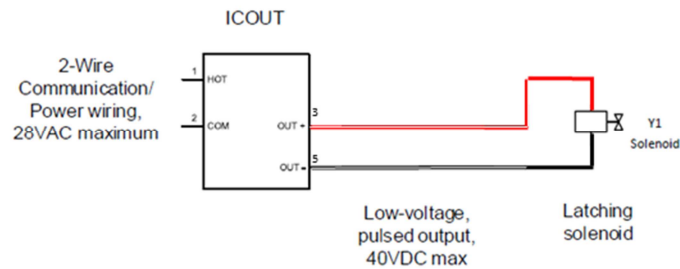

Figure 2 IC-OUT Controlling an Irrigation Valve with Latching Solenoid

### Output Connection Steps for a DC Latching irrigation Valve:

1. The IC-OUT device should arrive from the factory with wire ends stripped. If not, strip approximately 1" of insulation from each wire. Take care not to score the copper strands.
2. Strip approximately 1" of insulation from each DC Latching Solenoid connection wire to be spliced with IC-OUT output control wires. Take care not to score copper conductors.
  - a. Connect IC-OUT Output (+) (red-with-white stripe) wire to the latching solenoid (+) control input. (Typically the red wire)
  - b. Connect IC-OUT Output (-) (black-with-white stripe) wire to the latching solenoid (-) control input. (Typically the black wire)
3. Add suitable protection to the splices using Rain Bird DBRY splice kits for each splice, securing the splice with the wire nut then inserting the splice completely into the grease cap. **Note that grease caps are single-use; do NOT attempt to reuse them. In all cases follow local electrical codes.**
4. **Proceed to Page 17** "Installation Step #2 - Connect IC Field Wiring"



### 1.B - Output Connection Steps for Latching Relay Applications:

1. The IC-OUT device should arrive from the factory with control wire ends stripped. If not, strip approximately 3/4" of insulation from each wire. Take care not to score the copper strands.
2. If using a DIN mounting rail, securely mount the rail in an enclosure which meets local building and electrical codes.
3. Insert the DC latching relay into the relay mounting socket by aligning the pins in the relay with the contacts in the mounting socket. The relay and socket are keyed to prevent misalignment.
4. Install the relay assembly onto the DIN mounting rail and assure the assembly is securely locked into place.
5. Assure there is no live power supplied to the external power input or output wire by unplugging or switching off the circuit breaker. Connect the external power input wire to the relay socket input [terminal 9].
  - a. ALL connections must be made in accordance with the manufacturer's documentation for both the relay and the field equipment, and must comply with local building codes.
  - b. **Do NOT make any connections to the EXTERNAL POWER N/O, or N/C terminals at this time. Relays may arrive in either latch state after shipment and electrical shock could occur!**

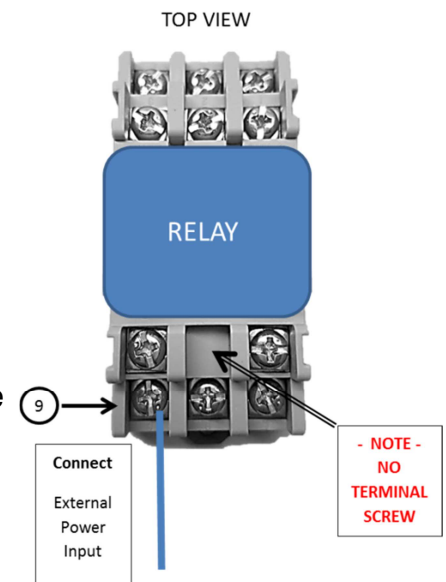



6. Connect the IC-OUT control outputs to the latching relay socket control inputs.

- a. Connect IC-OUT Output (red-with-white stripe) wire to the latching relay control input, typically denoted “B” or “A2”.
- b. Connect IC-OUT Output (black-with-white stripe) wire to the latching relay control input, typically denoted “A” or “A1”
- c. Do NOT connect the IC-OUT (solid red) wire or the IC-OUT (solid black) wire at this step
- d. **Do NOT make any connections to the EXTERNAL POWER N/O, or N/C terminals at this time. Relays may arrive in either latch state after shipment!**

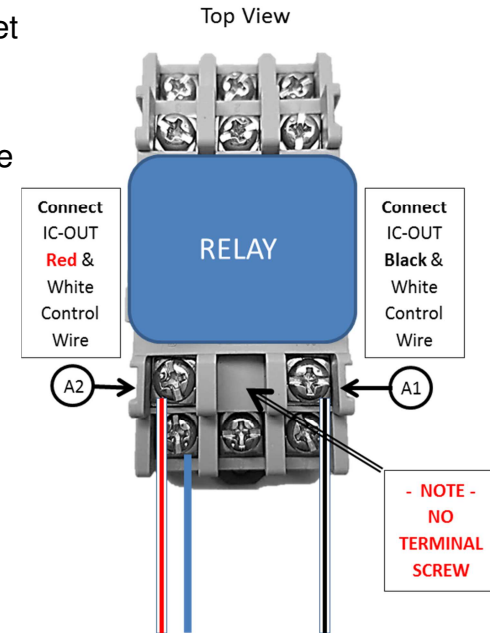

7. **Proceed to Page 17** - “Installation Step #2 - Connect IC Field Wiring”



## **Installation Step #2 - Connect IC System™ Field Wiring** (DC Latching Solenoid and Relay Applications)

1. Assure the IC wire path that the IC-OUT will be connected to is powered OFF.
2. The IC-OUT device should arrive from the factory with wire ends stripped. If not, strip approximately 1" of insulation from each wire. Take care not to score the copper strands.
3. Strip approximately 1" of insulation from each MAXI™ wire (IC System™ field wiring) to be spliced with IC-OUT. Take care not to score copper conductor.
4. Connect the IC-OUT (red) wire to the MAXI™ (red) wire. The IC-OUT to MAXI™ connection should be solid red on both sides of the splice.
5. Connect the IC-OUT (black) wire to the MAXI™ (black) wire. The IC-OUT to MAXI™ connection should be solid black on both sides of the splice.
6. Add suitable protection to the splices using a Rain Bird DBRY splice kit for the red-red and black-black splices just made.
7. Secure each splice with the wire nut then insert the splice completely into the grease cap. **Note that grease caps are single-use; do not attempt to reuse them.**

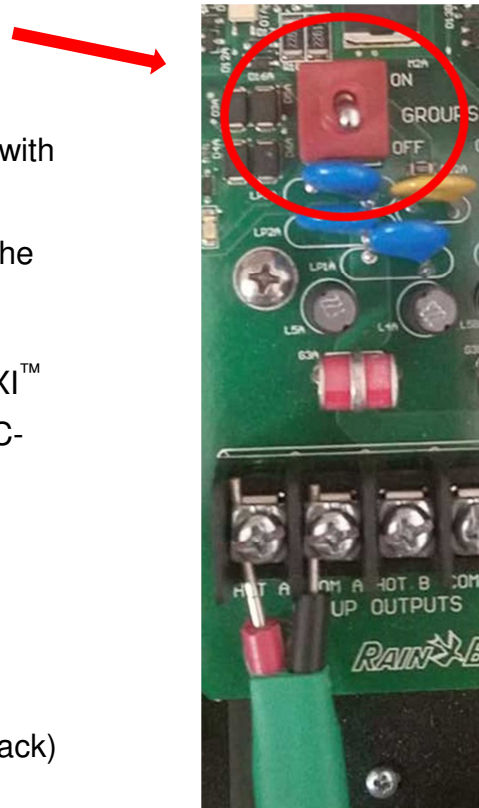

## ***Installation Step #3 - Complete Field Installation***

1. Double-check safety of all connections. Assure that all electrical codes have been followed and that no exposed wire ends are present.
2. Assure that all connections are suitably protected from surrounding environment.
3. Apply power to the IC System™ wire path.
  - a. **Allow two (2) minutes** for all IC System™ devices on the wire path to power-up before performing operations.
  - b. After two (2) minutes, the IC-OUT will be in the OFF state and you may complete installation for latching relay applications.

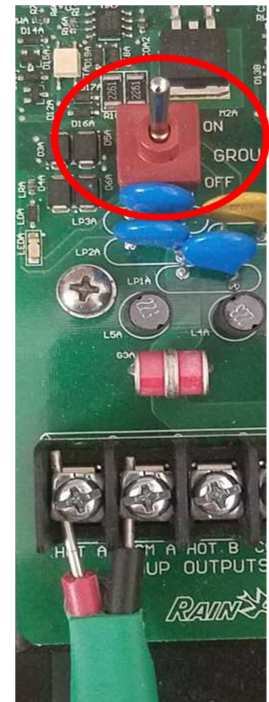

## 4. For the Latching Relay Application:

- a. Connect the field equipment or pump start relay as appropriate for the application to the external power output terminal on the relay socket. (This is typically the External power N/O output, terminal 6).
- b. ALL connections must be made in accordance with the manufacturer's documentation for both the relay and the field equipment, and must comply with local building codes. If necessary consult a licensed electrician to perform this connection.

5. Activate the circuit breaker and provide live power to the External Power input / output terminals.

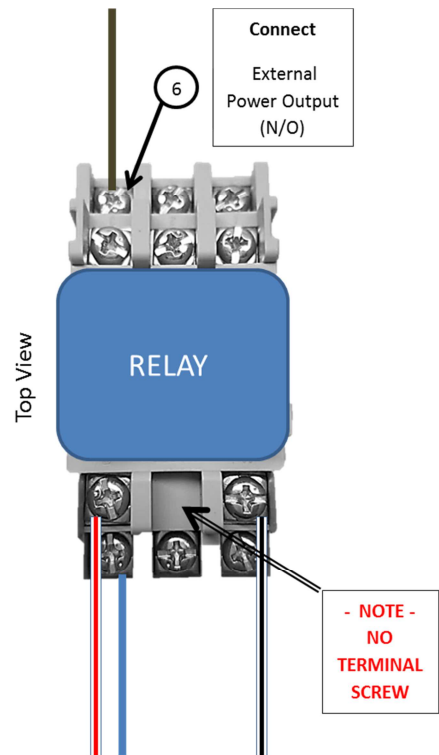

## Installation Step #4 - Configure Rain Bird Central Control Software

1. Activate Rain Bird Central Control software (version 8.1.0 or higher) on the central control pc and select System Settings to check the Integrated Control Interface (ICI) configuration:

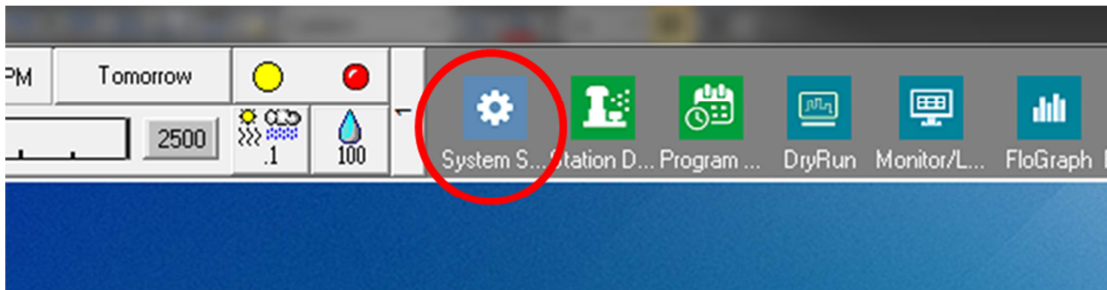

2. Verify that the System Settings dialog box shows a configured ICI interface (as shown below; the Port number and Field Box number are not critical but the ICI should be selected with a checkmark and the Port should not be "Demo"):

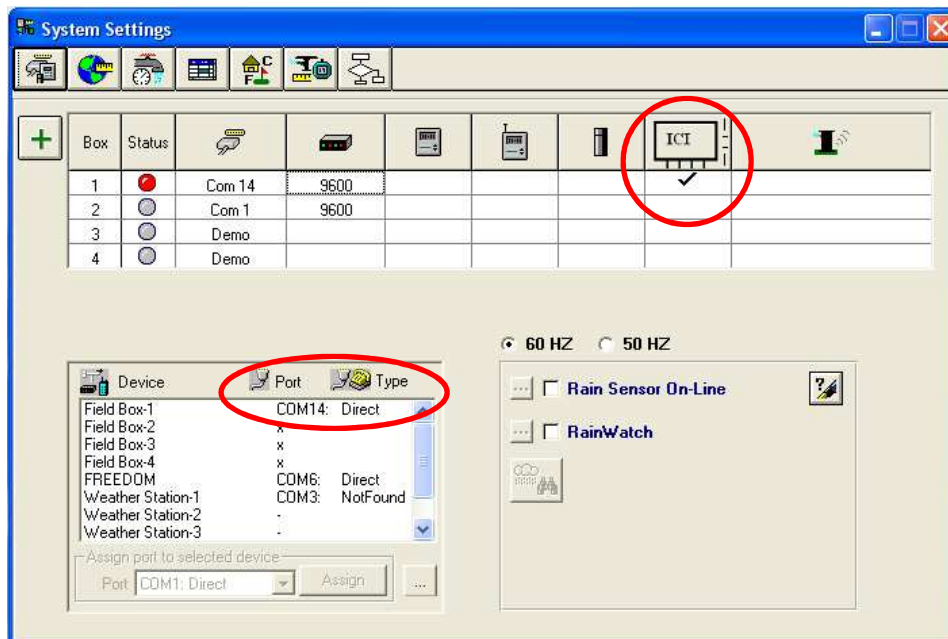

If no ICI is configured, refer to the IC System™ Installation instructions to complete this step.



3. There are two classes of control outputs you may wish to add to Rain Bird central control: general-purpose electrical control outputs, and booster pump control outputs. Separate sections describe configuration and operation of each device class.
  - a. General-purpose electrical control outputs might be used to control irrigation valves, fans, landscape lighting, water features, or other scheduled and/or manually operated electrical devices.
  - b. Booster pump control outputs are used to engage pumps to supply water to a section of the hydraulic system under Flo-Manager<sup>®</sup> control in response to irrigation requirements.

## 4.A – Setting Up General-Purpose Electrical Control Outputs

1. General purpose electrical outputs are configured identically to an irrigation station. Rain Bird recommends separating electrical stations from hydraulic irrigation stations in the station detail so that electrical stations are not included in Flow Management.

To create a new general-purpose electrical output station, select Station Detail:

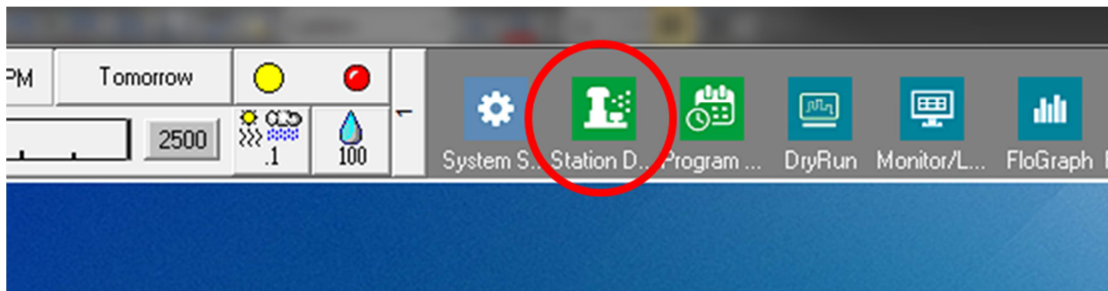

2. In the Station Detail window shown below, select the Course, Hole and Area used for general purpose electrical devices in your system (the example shows Miscellaneous area used for such devices):

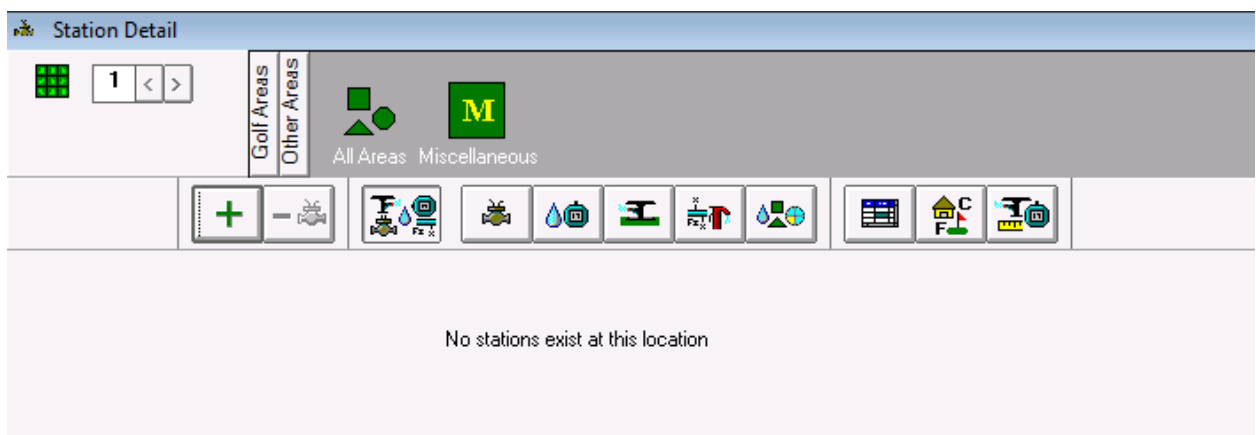



3. Create a new station in the selected area by clicking the “+” toolbar button. The new empty station entry is shown below:



4. Select the ICI wire path where the IC-OUT is connected and enter the IC-OUT address noted from the barcode label. In the example below, the IC-OUT is connected to wire path 1 and its address is 0FE93F:

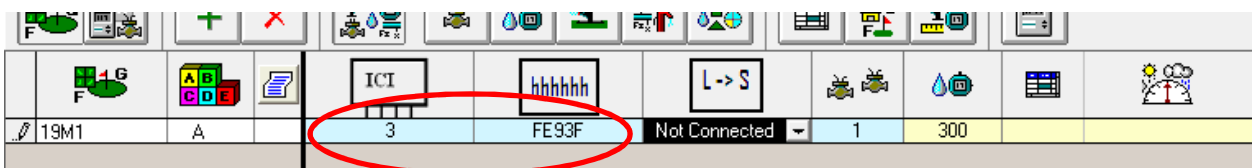

5. Close the Station Detail window after adding the IC-OUT device to establish a Fast Connect address with the device and prepare for operation. This step matches adding a new ICM station to the system.

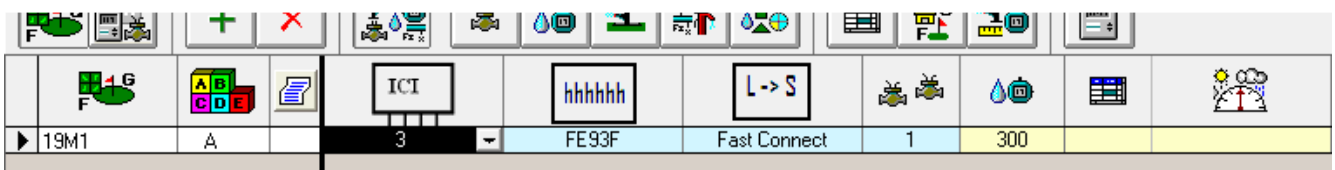

6. Once the station connection is completed, the new general purpose station can be used in a program or in manual operations by referring to its identifier, 19M1 in our example.



**“Best Practice” programming method for Activations Exceeding 8.5 hours**

The “Best Practice” programming method to operate a station in excess of the 499 minute maximum station run time in Rain Bird Central Control is provided below.

Our Example program shows a “Water Feature” program controlling an IC-OUT connected via a latching relay (as in Figure 1 above) to enable operation of a water feature during open hours for the club:

- a. The “Water Feature” program is set to start at 6:30am, 7 days per week at 100% water budget.

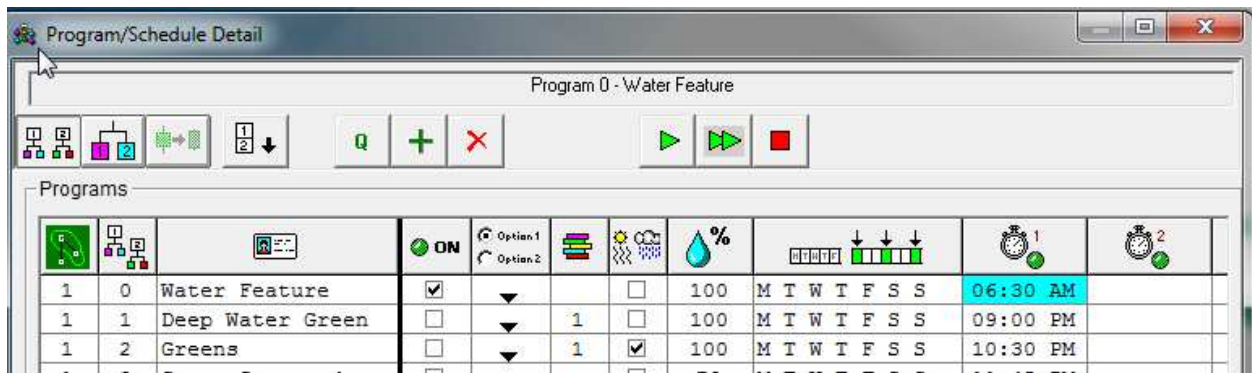

- b. A schedule is added to the “Water Feature” program. No Schedule start time is required because the schedule will follow the program start time, Days of the week and water budget for the schedule are set identically to the program.

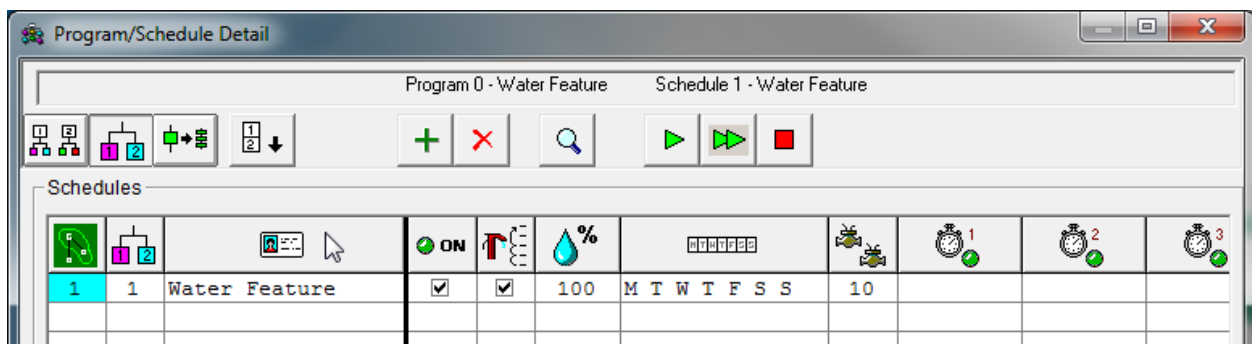



- c. The following station sequence is added to the “Water Feature” Program and “Water Feature” schedule. The station sequence reflects the IC-OUT station (19M1) running three (3) consecutive 300 minute cycles for a total of 15 hours. The central is not designed to run the same station simultaneously and will stack these activations to run in order. Activating the same station three times in a row will achieve a 900 minute (15 hour) consecutive run time.

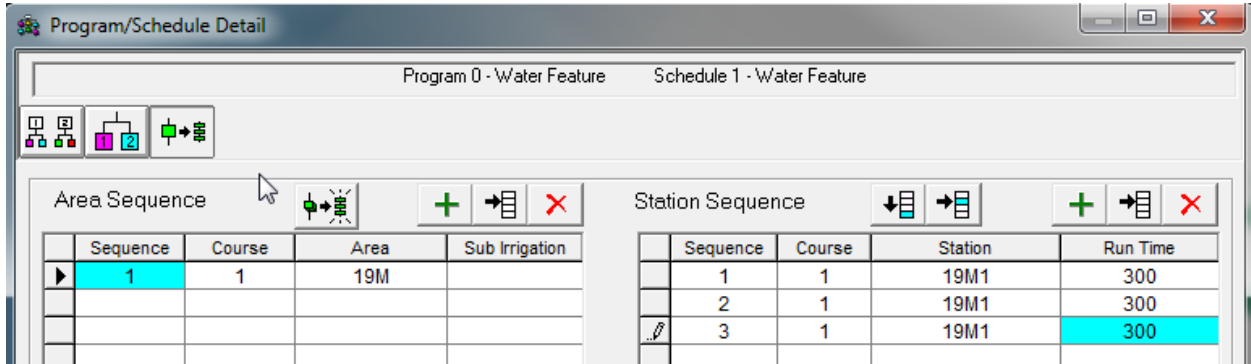

Note – Do NOT attempt to use seasonal adjustments or water budgets to increase total run time in excess of 499 minutes. Use the method presented above to achieve total run times in excess of 8.5 hours.

## 4.B – Setting Up Booster Pump Control Outputs

1. Booster Pump control outputs are configured similarly to an irrigation station. However, the booster pump control outputs must be configured as “booster pump” stations so that they are not counted as flow managed irrigation stations.

To create a new booster pump output station, select Station Detail:

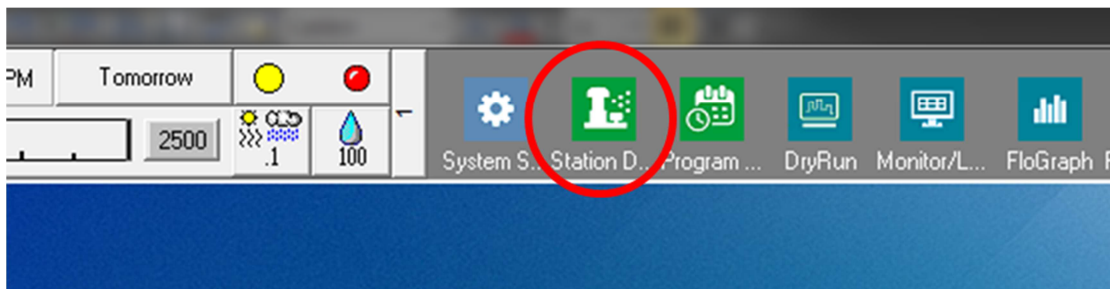

2. In the Station Detail window shown below, select the Course, Hole and Area used for general purpose electrical devices in your system (the example shows Miscellaneous area used for such devices):

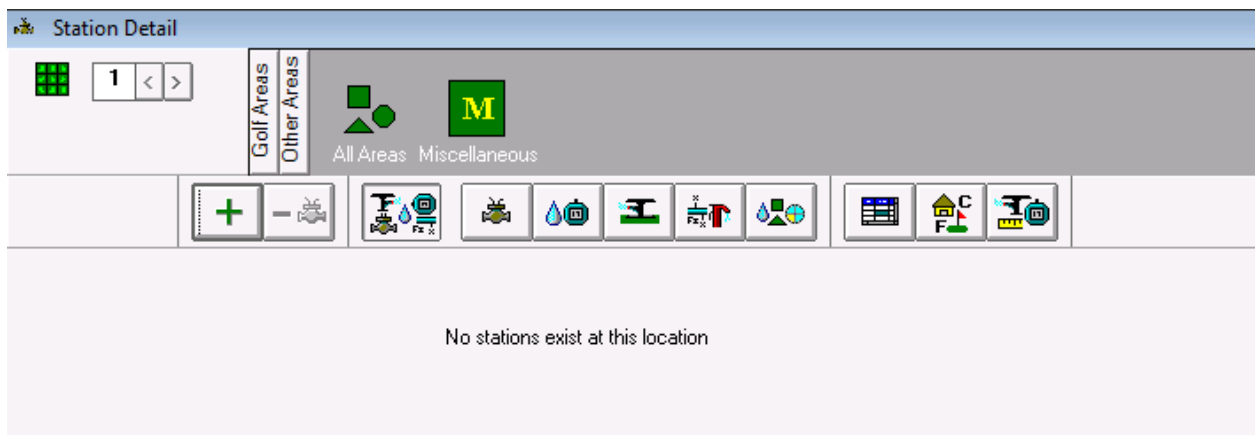



3. Create a new station in the selected area by clicking the “+” toolbar button. The empty new station entry is shown below:

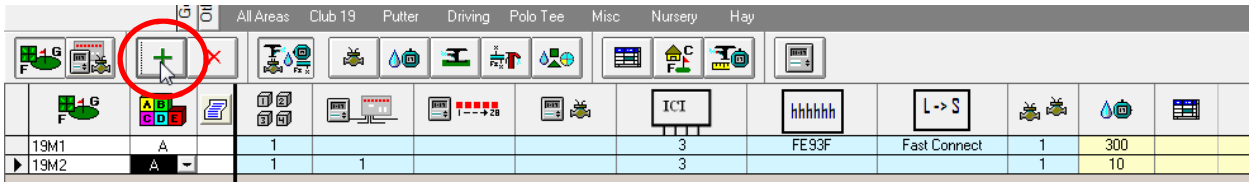

4. Select the ICI wire path where the IC-OUT is connected and enter the IC-OUT address noted from the barcode label. In the example below, the IC-OUT is connected to wire path 3 and its address is 0FE922:

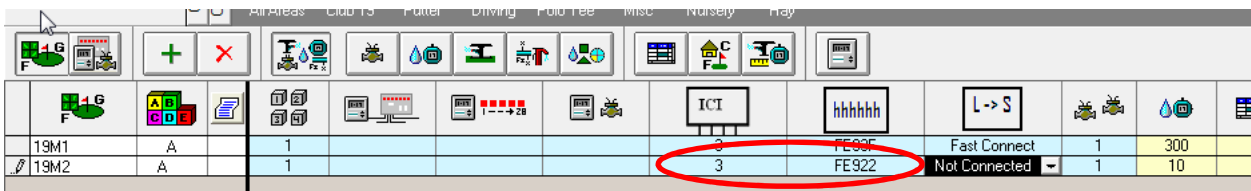

5. Attach the Booster Pump attribute to the IC-OUT station as shown below, Note that you must scroll the blue Station Detail columns to the left to view this field:

- a. Setting the Booster Pump attribute in the Station Detail informs the central to ignore flow and electrical limits typically assigned to normal stations.

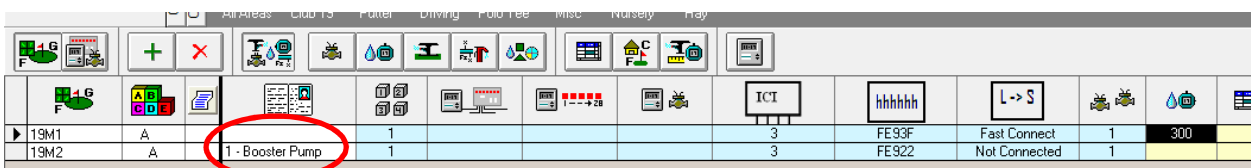

6. Close Station Detail to confirm setting the Booster Pump attribute and Fast Connect the IC-OUT. Any FloZone irrigation in the hydraulic diagram assigned under the booster pump station will activate the assigned booster pump station.

7. Create a booster pump station in the Flo-Manager® hydraulic diagram.

Open Flo-Manager® from the 2<sup>nd</sup> scroll screen:

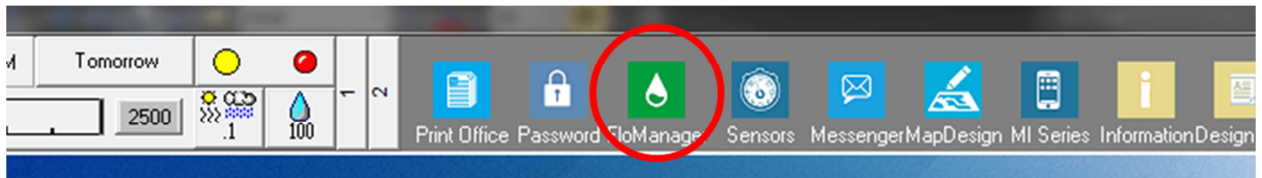

8. Determine the correct hydraulic location for the booster pump and add the pump. A simple example is shown below:

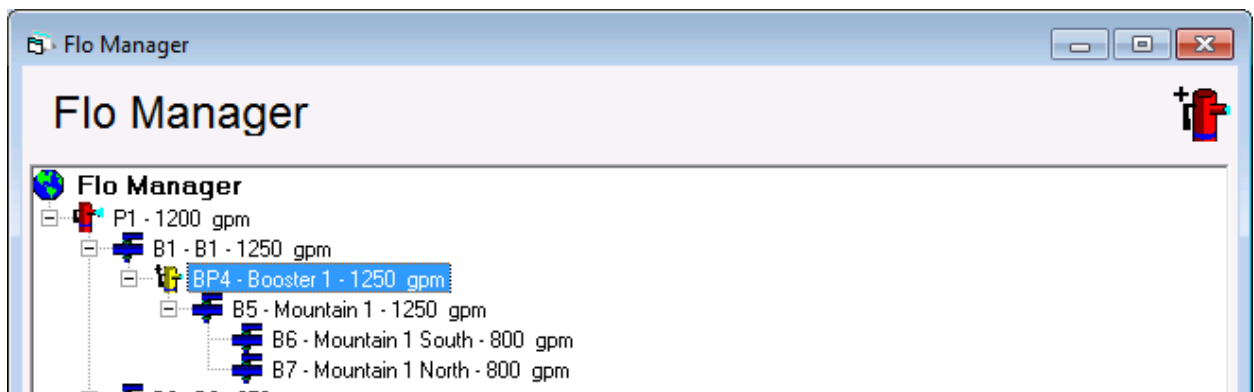



- Open Branch Properties for the booster pump by selecting the booster pump, right-clicking, and choosing Properties:

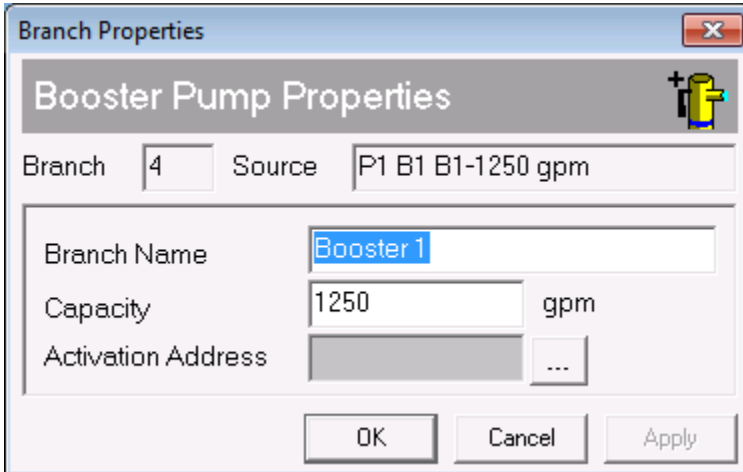

- Associate the booster pump station, 19M2, to the booster pump by clicking the button:

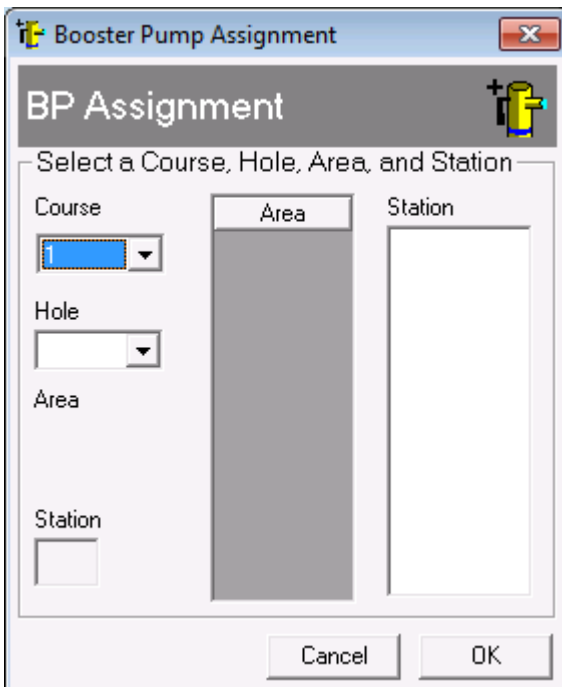

11. Choose the booster pump station using the Course, Hole, and Station controls:

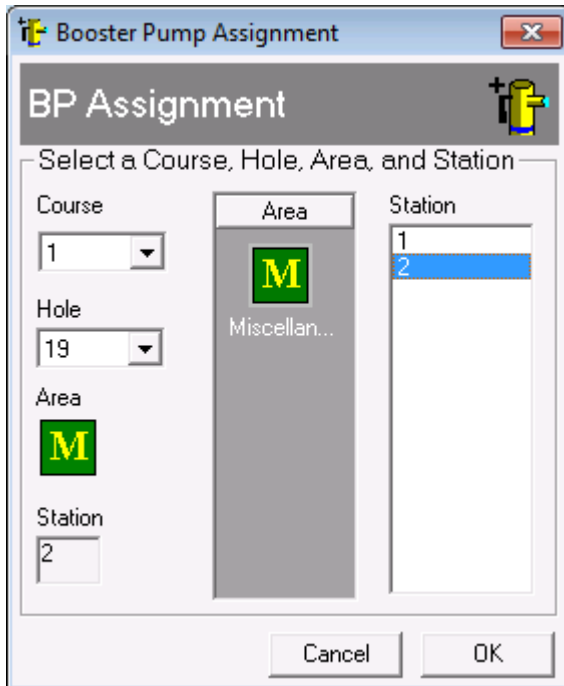

12. Assign related branches, flow zones and stations to the booster pump using the same method as creating a new Flo-Manager<sup>®</sup> tree.



Please direct inquiries for assistance on setting up or changing FloZones to your local Rain Bird distributor or Rain Bird GSP.



---

## ***IC-OUT Specifications***

Operating Temperature:	14°F to 125°F (-10°C to 51°C)
Storage Temperature:	-40°F to 150°F (-40°C to 65.5°C)
Operating Humidity:	75% max at 40°F to 108°F (4.4°C to 42.2°C)
Storage Humidity:	75% max at 40°F to 108°F (4.4°C to 42.2°C)
IC System™ Field Wiring Voltage	26-28 VAC (max)





**Rain Bird Corporation**

6991 E. Southpoint Road  
Tucson, AZ, 85706, U.S.A  
Phone: (520) 741-6100  
Fax: (520) 741-6522

**Rain Bird Technical Services**

(866) GSP-XPRT (477-9778)  
(U.S. and Canada only)

**Specification Hotline**

(800) 458-3005  
(U.S. and Canada only)

**Rain Bird Corporation**

970 W. Sierra Madre Avenue  
Azusa, CA, 91702, U.S.A  
Phone: (626) 812-3400  
Fax: (626) 812-3411

**Rain Bird International, Inc.**

100 W. Sierra Madre Avenue  
Azusa, CA, 91702, U.S.A  
Phone: (626) 963-9311  
Fax: (626) 963-4287

® Registered Trademark of Rain  
Bird Corporation  
© 2018 Rain Bird Corporation  
1/2018